

SQart

DESCRIPTION

Desks

How to order a desk

The SQart system requires ordering in component form:

- a desktop with a fixed frame
- a base (legs)

The structure of the desk makes it possible to use various leg types with the same frame – please note that the base and desktop depth dimension should match.

The following is an example shows how to order a desk:

SQart

RECTANGULAR DESKS WITH "O" LEGS

HEIGHT: 72 CM

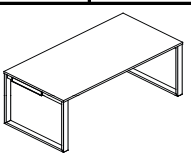
													melamine + 1				
													N fixed top		S sliding top		
																	
			width				depth										
WNSR	0	6	N	N	N	Z	120 cm							80 cm	120,-	207,-	
WNSR	0	8	N	N	N	Z	140 cm								151,-	238,-	
WNSR	1	0	N	N	N	Z	160 cm								156,-	243,-	
WNSR	1	2	N	N	N	Z	180 cm								169,-	255,-	
WNSR	1	4	N	N	N	Z	200 cm	For base type : C						177,-	262,-		
WNSR	2	5	N	N	N	Z	140 cm							100 cm	153,-	257,-	
WNSR	2	6	N	N	N	Z	160 cm								160,-	264,-	
WNSR	2	7	N	N	N	Z	180 cm								172,-	274,-	
WNSR	2	8	N	N	N	Z	200 cm	For base type : E						178,-	281,-		
													+				
													alu, white, black (AL, BI, CZ)		base (desk`s depth)		
WNSNBC6N	0	N	N	N	N	without height adjustment									C	133,-	80 x 80
WNSNBC6N	0	N	N	N	N	without height adjustment									E	142,-	100 x 100

* colour of the cable outlet always matching the base colour

When ordering a desk with a 180x80 cm desktop and "O" legs, select the **WNSR12LNNZ** desktop and the **WNSNBC6N1NN** base.

A desk order will therefore comprise two reference numbers:

WNSR12LNNZ (desktop) and **WNSNBC6N1NN** (base)

SQart

RECTANGULAR DESKS WITH 4 METAL RECTANGULAR LEGS

HEIGHT: 72 CM

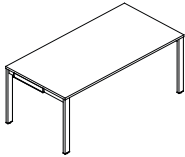
										... without outlet for cables			
										... left outlet for cables			
										... right outlet for cables			
										... middle outlet for cables			
										... fixed top			
										... sliding top			
										melamine + 1			
										melamine + 1			
										N fixed top			
										S sliding top			
													
Top										width	depth		
W	N	S	R	0	5	N	N	N	Z	120 cm	60 cm	116,-	197,-
W	N	S	R	0	7	N	N	N	Z	140 cm		141,-	221,-
W	N	S	R	0	9	N	N	N	Z	160 cm	For base type : A	146,-	227,-
W	N	S	R	1	5	N	N	N	Z	120 cm	70 cm	117,-	198,-
W	N	S	R	1	6	N	N	N	Z	140 cm		159,-	239,-
W	N	S	R	1	7	N	N	N	Z	160 cm		166,-	247,-
W	N	S	R	1	8	N	N	N	Z	180 cm	For base type : H	179,-	258,-
W	N	S	R	0	6	N	N	N	Z	120 cm	80 cm	129,-	222,-
W	N	S	R	0	8	N	N	N	Z	140 cm		162,-	255,-
W	N	S	R	1	0	N	N	N	Z	160 cm		168,-	261,-
W	N	S	R	1	2	N	N	N	Z	180 cm		182,-	274,-
W	N	S	R	1	4	N	N	N	Z	200 cm	For base type : H	190,-	282,-
W	N	S	R	2	1	N	N	N	Z	140 cm	90 cm	165,-	274,-
W	N	S	R	2	2	N	N	N	Z	160 cm		173,-	281,-
W	N	S	R	2	3	N	N	N	Z	180 cm		186,-	293,-
W	N	S	R	2	4	N	N	N	Z	200 cm	For base type : I	194,-	300,-
W	N	S	R	2	6	N	N	N	Z	160 cm	100 cm	172,-	284,-
W	N	S	R	2	7	N	N	N	Z	180 cm		184,-	295,-
W	N	S	R	2	8	N	N	N	Z	200 cm	For base type : I	192,-	302,-
										Z	... top with fixed frame		

										0 ... for top without outlet for cables				
										1 ... for top with one outlet for cables *				
Base (Legs)										alu, white, black (AL, BI, CZ)		base (desk`s depth)		
W	N	S	N	B	A	2	N	0	N	N	without height adjustment	A	100,-	60 x 60
W	N	S	N	B	A	2	H	0	N	N	with manual height adj. (68-82 cm)		162,-	
W	N	S	N	B	H	2	N	0	N	N	without height adjustment	H	105,-	70 x 70 - 80 x 80
W	N	S	N	B	H	2	H	0	N	N	with manual height adj. (68-82 cm)		167,-	
W	N	S	N	B	I	2	N	0	N	N	without height adjustment	I	111,-	90 x 90 - 100 x 100
W	N	S	N	B	I	2	H	0	N	N	with manual height adj. (68-82 cm)		173,-	

* colour of the cable outlet always matching the base colour

SQart

RECTANGULAR DESKS WITH 4 WOODEN SQUARE LEGS

HEIGHT: 72 CM

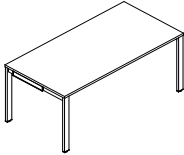
												veneer +4			
												fixed top			
															
N											... without outlet for cables				
L											... left outlet for cables				
R											... right outlet for cables				
M											... middle outlet for cables				
Top										width	depth				
W	N	S	R	1	0	N	N	N	Z	160 cm	80 cm			369,-	
W	N	S	R	1	2	N	N	N	Z	180 cm		For base type : H		403,-	
W	N	S	R	2	3	N	N	N	Z	180 cm	90 cm			420,-	
W	N	S	R	2	4	N	N	N	Z	200 cm		For base type : I		448,-	
W	N	S	R	2	8	N	N	N	Z	200 cm	100 cm	For base type : I		484,-	

												wooden legs + 4 (LN, LV, CB)		base (desk`s depth)	
0											... for top without outlet for cables				
1											... for top with one outlet for cables *				
Base (Legs)															
W	N	S	N	B	H	7	N	0	N	N	without height adjustment	H	202,-	70 x 70 - 80 x 80	
W	N	S	N	B	I	7	N	0	N	N	without height adjustment	I	220,-	90 x 90 - 100 x 100	

* for legs in LN colour - outlet for cables light gray
for legs in colour LV and CB - outlet for cables black

SQart

RECTANGULAR DESKS WITH 2 METAL LEGS AND ORGA TOWER HEIGHT: 72 CM

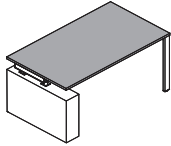
										melamine + 1	
N	... without outlet for cables										
L	... left outlet for cables										
R	... right outlet for cables										
M	... middle outlet for cables										
Top											
Low Orga Tower h=56 cm						width		depth			
W N S R 0 6	N	N	N	Z		120 cm		 80 cm		129,-	
W N S R 0 8	N	N	N	Z		140 cm				162,-	
W N S R 1 0	N	N	N	Z		160 cm				168,-	
										For base type : P	

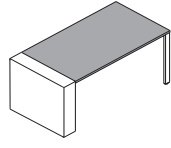
Orga Tower h=72 cm											
W N S R 0 6	N	N	N	Z		120 cm+OT (16,9 cm)		 80 cm		129,-	
W N S R 0 8	N	N	N	Z		140 cm+OT (16,9 cm)				162,-	
W N S R 1 0	N	N	N	Z		160 cm+OT (16,9 cm)				168,-	
										For base type : R	

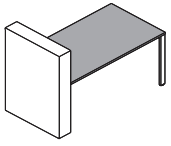
High Orga Tower h =117 cm											
W N S R 0 6	N	N	N	Z		120 cm+OT (16,9 cm)		 80 cm		129,-	
W N S R 0 8	N	N	N	Z		140 cm+OT (16,9 cm)				162,-	
W N S R 1 0	N	N	N	Z		160 cm+OT (16,9 cm)				168,-	
										For base type : S	

Z ... top with fixed frame

* left Orga Tower on the drawing

0 ... for top without outlet for cables
1 ... for top with one outlet for cables *

L ... left Orga Tower
R ... right Orga Tower

Base (Legs)

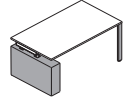
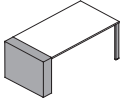
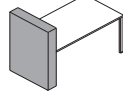
										alu, white, black (AL, BI, CZ)		Orga T +1		
W N S N T P 2	N	0	L	N		+ Orga Tower 56 cm		 P		363,-				
W N S N T R 2	N	0	L	N		+ Orga Tower 72 cm				 R		398,-		
W N S N T S 2	N	0	L	N		+ Orga Tower 117 cm						 S		502,-

* colour of outlet for cables always as colour of legs

The Orga Towers are not equipped. List of accessories on page 41

SQart

RECTANGULAR DESKS WITH "C" LEGS

HEIGHT: 72 CM

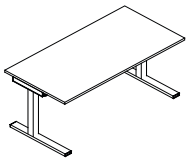
										melamine + 1			
										N fixed top	S sliding top		
N	... without outlet for cables												
L	... left outlet for cables												
R	... right outlet for cables												
M	... middle outlet for cables												
N	... fixed top												
S	... sliding top												
Top													
W	N	S	R	1	5	N	N	N	Z	width	depth		
										120 cm	70 cm	117,-	198,-
W	N	S	R	1	6	N	N	N	Z	140 cm		159,-	239,-
W	N	S	R	1	7	N	N	N	Z	160 cm		166,-	247,-
W	N	S	R	1	8	N	N	N	Z	180 cm	For base type : B	179,-	258,-
W	N	S	R	0	6	N	N	N	Z	120 cm	80 cm	129,-	222,-
W	N	S	R	0	8	N	N	N	Z	140 cm		162,-	255,-
W	N	S	R	1	0	N	N	N	Z	160 cm		168,-	261,-
W	N	S	R	1	2	N	N	N	Z	180 cm	For base type : C	182,-	274,-
W	N	S	R	1	4	N	N	N	Z	200 cm		190,-	282,-
W	N	S	R	2	1	N	N	N	Z	140 cm	90 cm	165,-	274,-
W	N	S	R	2	2	N	N	N	Z	160 cm		173,-	281,-
W	N	S	R	2	3	N	N	N	Z	180 cm	For base type : D	186,-	293,-
W	N	S	R	2	4	N	N	N	Z	200 cm		194,-	300,-
W	N	S	R	2	6	N	N	N	Z	160 cm	100 cm	172,-	284,-
W	N	S	R	2	7	N	N	N	Z	180 cm	For base type : E	184,-	295,-
W	N	S	R	2	8	N	N	N	Z	200 cm		192,-	302,-
Z	... top with fixed frame												

Electrical height adjustment (68-131 cm) in desks marked: 
Maximum capacity for desk with electrical height adjustment: 85 kg

										alu, white, black (AL, BI, CZ)		base (desk`s depth)	
0	... for top without outlet for cables												
1	... for top with one outlet for cables *												
Base (Legs)													
W	N	S	N	B	B	3	N	0	N	N	without height adjustment	171,-	70 x 70
W	N	S	N	B	B	3	H	0	N	N	with manual height adj. (68-82 cm)	198,-	
W	N	S	N	B	C	3	N	0	N	N	without height adjustment	175,-	80 x 80
W	N	S	N	B	C	3	E	0	N	N	with electrical adjustment, width 140 cm	1 000,-	
W	N	S	N	B	C	3	F	0	N	N	with electrical adjustment, width 160 cm	1 002,-	
W	N	S	N	B	C	3	G	0	N	N	with electrical adjustment, width 180 cm	1 003,-	
W	N	S	N	B	C	3	H	0	N	N	with manual height adj. (68-82 cm)	202,-	
W	N	S	N	B	D	3	N	0	N	N	without height adjustment	179,-	90 x 90
W	N	S	N	B	D	3	H	0	N	N	with manual height adj. (68-82 cm)	206,-	
W	N	S	N	B	E	3	N	0	N	N	without height adjustment	183,-	100 x 100
W	N	S	N	B	E	3	H	0	N	N	with manual height adj. (68-82 cm)	210,-	

* colour of the cable outlet always matching the base colour

SQart

RECTANGULAR DESKS WITH "C" LEG AND ORGA TOWER HEIGHT: 72 CM

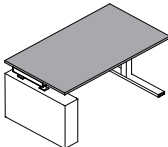
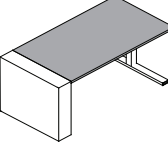
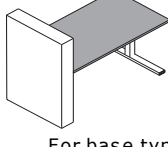
											melamine + 1			
		N		... without outlet for cables										
		L		... left outlet for cables										
		R		... right outlet for cables										
		M		... middle outlet for cables										
Top														
Low Orga Tower h=56 cm											width		depth	
W	N	S	R	0	6	N	N	N	Z		120 cm	 For base type : P	80 cm	129,-
W	N	S	R	0	8	N	N	N	Z		140 cm		162,-	
W	N	S	R	1	0	N	N	N	Z		160 cm		168,-	
Orga Tower h=72 cm														
W	N	S	R	0	6	N	N	N	Z		120 cm+OT (16,9 cm)	 For base type : R	80 cm	129,-
W	N	S	R	0	8	N	N	N	Z		140 cm+OT (16,9 cm)		162,-	
W	N	S	R	1	0	N	N	N	Z		160 cm+OT (16,9 cm)		168,-	
High Orga Tower h =117 cm														
W	N	S	R	0	6	N	N	N	Z		120 cm+OT (16,9 cm)	 For base type : S	80 cm	129,-
W	N	S	R	0	8	N	N	N	Z		140 cm+OT (16,9 cm)		162,-	
W	N	S	R	1	0	N	N	N	Z		160 cm+OT (16,9 cm)		168,-	
											Z ... top with fixed frame		* left Orga Tower on the drawing	

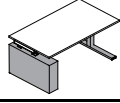
		0		... for top without outlet for cables										
		1		... for top with one outlet for cables *										
		L		... left Orga Tower										
		R		... right Orga Tower										
Base (Legs)											alu, white, black (AL, BI, CZ)		Orga T +1	
W	N	S	N	T	P	3	N	0	L	N	+ Orga Tower 56 cm	 P	417,-	
W	N	S	N	T	R	3	N	0	L	N	+ Orga Tower 72 cm		R	452,-
W	N	S	N	T	S	3	N	0	L	N	+ Orga Tower 117 cm		S	556,-

* colour of outlet for cables always as colour of legs

The Orga Towers are not equipped. List of accessories on page 41

SQart

RECTANGULAR DESKS WITH "O" LEGS

HEIGHT: 72 CM

N	... without outlet for cables
L	... left outlet for cables
R	... right outlet for cables
M	... middle outlet for cables

N	... fixed top
S	... sliding top

melamine + 1	
N fixed top	S sliding top

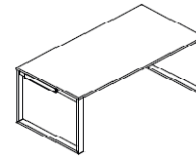

Top										width	depth		
W	N	S	R	0	6	N	N	N	Z	120 cm	80 cm	129,-	222,-
W	N	S	R	0	8	N	N	N	Z	140 cm		162,-	255,-
W	N	S	R	1	0	N	N	N	Z	160 cm		168,-	261,-
W	N	S	R	1	2	N	N	N	Z	180 cm		182,-	274,-
W	N	S	R	1	4	N	N	N	Z	200 cm	For base type : C	190,-	282,-

W	N	S	R	2	5	N	N	N	Z	140 cm	100 cm	164,-	276,-
W	N	S	R	2	6	N	N	N	Z	160 cm		172,-	284,-
W	N	S	R	2	7	N	N	N	Z	180 cm		184,-	295,-
W	N	S	R	2	8	N	N	N	Z	200 cm	For base type : E	192,-	302,-

Z ... top with fixed frame

0	... for top without outlet for cables
1	... for top with one outlet for cables *

Base (Legs)										alu, white, black (AL, BI, CZ)	base (desk`s depth)			
W	N	S	N	B	C	6	N	0	N	N	without height adjustment	C	142,-	80 x 80
W	N	S	N	B	E	6	N	0	N	N	without height adjustment	E	152,-	100 x 100

* colour of the cable outlet always matching the base colour

SQart

RECTANGULAR DESKS WITH "O" LEG AND ORGA TOWER

HEIGHT: 72 CM

Top										melamine + 1		
N	... without outlet for cables											
L	... left outlet for cables											
R	... right outlet for cables											
M	... middle outlet for cables											
Low Orga Tower h=56 cm												
W	N	S	R	O	6	N	N	Z		width	depth	
										120 cm	80 cm	129,-
										140 cm		162,-
										160 cm		168,-
										For base type : P		
Orga Tower h=72 cm												
W	N	S	R	O	6	N	N	Z		width	depth	
										120 cm+OT (16,9 cm)	80 cm	129,-
										140 cm+OT (16,9 cm)		162,-
										160 cm+OT (16,9 cm)		168,-
										For base type : R		
High Orga Tower h =117 cm												
W	N	S	R	O	6	N	N	Z		width	depth	
										120 cm+OT (16,9 cm)	80 cm	129,-
										140 cm+OT (16,9 cm)		162,-
										160 cm+OT (16,9 cm)		168,-
										For base type : S		

Z ... top with fixed frame

* left Orga Tower on the drawing

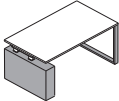
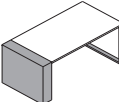
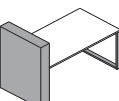
Base (Legs)										alu, white, black (AL, BI, CZ)		Orga T +1		
0	... for top without outlet for cables													
1	... for top with one outlet for cables *													
L	... left Orga Tower													
R	... right Orga Tower													
W	N	S	N	T	P	6	N	0	L	N				
											+ Orga Tower 56 cm		P	390,-
											+ Orga Tower 72 cm		R	425,-
											+ Orga Tower 117 cm		S	529,-

* colour of outlet for cables always as colour of legs

The Orga Towers are not equipped. List of accessories on page 41

SQart

"L" SHAPED DESKS WITH 5 METAL RECTANGULAR LEGS HEIGHT: 72 CM

										N ... without outlet for cables		L ... left outlet for cables		R ... right outlet for cables		M ... middle outlet for cables		L ... left desk		R ... right desk		melamine + 1	
										width		depth											
W	N	S	L	3	2	N	N	L	Z	140x120 cm		80/60 cm								308,-			
W	N	S	L	1	2	N	N	L	Z	160x120 cm										314,-			
W	N	S	L	1	5	N	N	L	Z	180x120 cm										327,-			
W	N	S	L	1	8	N	N	L	Z	200x120 cm		For base type : K								342,-			
																				* left version on the drawing			
W	N	S	G	3	1	N	N	L	Z	140x140 cm		80/80 cm								310,-			
W	N	S	G	2	3	N	N	L	Z	160x160 cm		For base type : L								321,-			
										Z ... top with fixed frame													

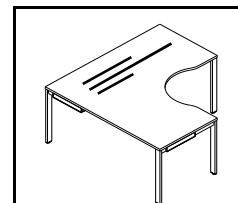
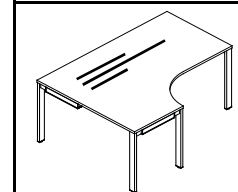

										0 ... for top without outlet for cables		1 ... for top with one outlet for cables *		L ... left version of base		P ... right version of base		alu, white, black (AL, BI, CZ)	
W	N	S	N	B	K	2	N	0	L	without height adjustment								134,-	
W	N	S	N	B	K	2	H	0	L	with manual height adj. (68-82 cm)		K						212,-	
W	N	S	N	B	L	2	N	0	N	without height adjustment								137,-	
W	N	S	N	B	L	2	H	0	N	with manual height adj. (68-82 cm)		L						215,-	

* colour of the cable outlet always matching the base colour

SQart

"L" SHAPED DESKS WITH "C" LEGS

HEIGHT: 72 CM

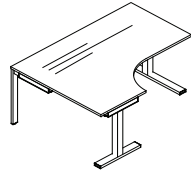
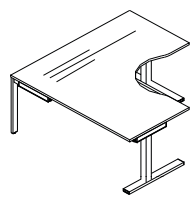
										N	... without outlet for cables			
										L	... left outlet for cables			
										R	... right outlet for cables			
										M	... middle outlet for cables			
										L	... left desk			
										R	... right desk			
										melamine + 1				
														
Top										width	depth			
W	N	S	L	3	2	N	N	L	Z	140x120 cm	80/60 cm	308,-		
W	N	S	L	1	2	N	N	L	Z	160x120 cm		314,-		
W	N	S	L	1	5	N	N	L	Z	180x120 cm		327,-		
W	N	S	L	1	8	N	N	L	Z	200x120 cm	For base type : K	342,-		
										* left version on the drawing				
														
W	N	S	G	3	1	N	N	L	Z	140x140 cm	80/80 cm	310,-		
W	N	S	G	2	3	N	N	L	Z	160x160 cm	For base type : L	321,-		
										Z	... top with fixed frame			

										0	... for top without outlet for cables				
										1	... for top with one outlet for cables *				
										L	... left version of base				
										P	... right version of base				
Base (Legs)										alu, white, black (AL, BI, CZ)					
W	N	S	N	B	K	3	N	0	L	N	without height adjustment	190,-			
W	N	S	N	B	K	3	H	0	L	N	with manual height adj. (68-82 cm)	K	229,-		
W	N	S	N	B	L	3	N	0	N	N	without height adjustment	193,-			
W	N	S	N	B	L	3	H	0	N	N	with manual height adj. (68-82 cm)	L	232,-		

* colour of the cable outlet always matching the base colour

SQart

DESKS WITH 4 METAL RECTANGULAR LEGS

OTHER DESKS SHAPES

HEIGHT: 72 CM

N	... without outlet for cables			melamine + 1		melamine + 1	
L	... left outlet for cables			N fixed top		S sliding top	
R	... right outlet for cables						
M	... middle outlet for cables						
N	... fixed top			sloped desks			
S	... sliding top						
L	... left desk						
R	... right desk						
Top		width	depth				
WNS T 0 8	N N L Z	140 cm	100/80 cm	<p>For base type : J</p>			
WNS T 1 0	N N L Z	160 cm					
WNS T 1 2	N N L Z	180 cm					
WNS T 1 4	N N L Z	200 cm					
				* left version on the drawing			
				single wave desks			
WNS V 0 8	N N L Z	140 cm	100/80 cm	<p>For base type : J</p>			
WNS V 1 0	N N L Z	160 cm					
WNS V 1 2	N N L Z	180 cm					
WNS V 1 4	N N L Z	200 cm					
				* left version on the drawing			
				double wave desks			
WNS D 2 1	N N N Z	140 cm	90/90 cm	<p>For base type : I</p>			
WNS D 2 2	N N N Z	160 cm					
WNS D 2 3	N N N Z	180 cm					
WNS D 2 4	N N N Z	200 cm					
				* left version on the drawing			
				"wing" desks			
WNS Z 1 2	N N L Z	180 cm	100/80 cm	<p>For base type : J</p>			
WNS Z 1 4	N N L Z	200 cm					
				* left version on the drawing			
Z	... top with fixed frame						

0	... for top without outlet for cables			alu, white, black (AL, BI, CZ)		base (desk`s depth)	
1	... for top with one outlet for cables *						
Base (Legs)							
WNS N B J 2	N 0 N N	without height adjustment	J		108,-	100 x 80	
WNS N B J 2	H 0 N N	with manual height adj. (68-82 cm)			170,-		
WNS N B I 2	N 0 N N	without height adjustment	I		111,-	90 x 90 - 100 x 100	
WNS N B I 2	H 0 N N	with manual height adj. (68-82 cm)			173,-		

* colour of the cable outlet always matching the base colour

SQart

DESKS WITH "C" LEGS

OTHER DESKS SHAPES

HEIGHT: 72 CM

- N ... without outlet for cables
- L ... left outlet for cables
- R ... right outlet for cables
- M ... middle outlet for cables

- N ... fixed top
- S ... sliding top

- L ... left desk
- R ... right desk

Top

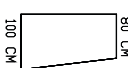
										width	depth																		
W	N	S	T	0	8	N	N	L	Z	140 cm	100/80 cm	 For base type : J		<table border="1"> <thead> <tr> <th colspan="2">sloped desks</th> </tr> <tr> <th>melamine + 1</th> <th>melamine + 1</th> </tr> <tr> <th>N fixed top</th> <th>S sliding top</th> </tr> </thead> <tbody> <tr> <td>175,-</td> <td>280,-</td> </tr> <tr> <td>183,-</td> <td>288,-</td> </tr> <tr> <td>197,-</td> <td>300,-</td> </tr> <tr> <td>204,-</td> <td>307,-</td> </tr> </tbody> </table>		sloped desks		melamine + 1	melamine + 1	N fixed top	S sliding top	175,-	280,-	183,-	288,-	197,-	300,-	204,-	307,-
sloped desks																													
melamine + 1	melamine + 1																												
N fixed top	S sliding top																												
175,-	280,-																												
183,-	288,-																												
197,-	300,-																												
204,-	307,-																												
W	N	S	T	1	0	N	N	L	Z	160 cm																			
W	N	S	T	1	2	N	N	L	Z	180 cm																			
W	N	S	T	1	4	N	N	L	Z	200 cm																			

* left version on the drawing

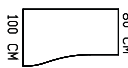
W	N	S	V	0	8	N	N	L	Z	140 cm	100/80 cm	 For base type : J		<table border="1"> <thead> <tr> <th colspan="2">single wave desks</th> </tr> </thead> <tbody> <tr> <td>176,-</td> <td>275,-</td> </tr> <tr> <td>184,-</td> <td>283,-</td> </tr> <tr> <td>197,-</td> <td>295,-</td> </tr> <tr> <td>205,-</td> <td>303,-</td> </tr> </tbody> </table>		single wave desks		176,-	275,-	184,-	283,-	197,-	295,-	205,-	303,-
single wave desks																									
176,-	275,-																								
184,-	283,-																								
197,-	295,-																								
205,-	303,-																								
W	N	S	V	1	0	N	N	L	Z	160 cm															
W	N	S	V	1	2	N	N	L	Z	180 cm															
W	N	S	V	1	4	N	N	L	Z	200 cm															

* left version on the drawing

W	N	S	D	2	1	N	N	N	Z	140 cm	90/90 cm	 For base type : D		<table border="1"> <thead> <tr> <th colspan="2">double wave desks</th> </tr> </thead> <tbody> <tr> <td>175,-</td> <td>279,-</td> </tr> <tr> <td>184,-</td> <td>287,-</td> </tr> <tr> <td>198,-</td> <td>299,-</td> </tr> <tr> <td>206,-</td> <td>308,-</td> </tr> </tbody> </table>		double wave desks		175,-	279,-	184,-	287,-	198,-	299,-	206,-	308,-
double wave desks																									
175,-	279,-																								
184,-	287,-																								
198,-	299,-																								
206,-	308,-																								
W	N	S	D	2	2	N	N	N	Z	160 cm															
W	N	S	D	2	3	N	N	N	Z	180 cm															
W	N	S	D	2	4	N	N	N	Z	200 cm															

W	N	S	Z	1	2	N	N	L	Z	180 cm	100/80 cm	 For base type : J		<table border="1"> <thead> <tr> <th colspan="2">"wing" desks</th> </tr> </thead> <tbody> <tr> <td>190,-</td> <td>288,-</td> </tr> <tr> <td>203,-</td> <td>299,-</td> </tr> </tbody> </table>		"wing" desks		190,-	288,-	203,-	299,-
"wing" desks																					
190,-	288,-																				
203,-	299,-																				
W	N	S	Z	1	4	N	N	L	Z	200 cm											

Z ... top with fixed frame

* left version on the drawing







Electrical height adjustment (68-131 cm) in desks marked: 

Maximum capacity for desk with electrical height adjustment: 85 kg

- 0 ... for top without outlet for cables
- 1 ... for top with one outlet for cables *

- L ... left version of base
- P ... right version of base

Base (Legs)

											alu, white, black (AL, BI, CZ)	base (desk's depth)	
W	N	S	N	B	J	3	N	Q	L	N	without height adjustment	180,-	100 x 80
W	N	S	N	B	J	3	E	Q	L	N	with electrical adjustment, width 140 cm 	only AL, BI 1 004,-	
W	N	S	N	B	J	3	F	Q	L	N	with electrical adjustment, width 160 cm 	1 006,-	
W	N	S	N	B	J	3	G	Q	L	N	with electrical adjustment, width 180 cm 	1 008,-	
W	N	S	N	B	J	3	H	Q	L	N	with manual height adj. (68-82 cm) J	206,-	
W	N	S	N	B	D	3	N	Q	N	N	without height adjustment	179,-	90 x 90
W	N	S	N	B	D	3	E	Q	N	N	with electrical adjustment, width 140 cm 	only AL, BI 1 004,-	
W	N	S	N	B	D	3	F	Q	N	N	with electrical adjustment, width 160 cm 	1 006,-	
W	N	S	N	B	D	3	G	Q	N	N	with electrical adjustment, width 180 cm 	994,-	
W	N	S	N	B	D	3	H	Q	N	N	with manual height adj. (68-82 cm) D	206,-	

* colour of the cable outlet always matching the base colour

SQart

SINGLE WAVE DESKS WITH "O" LEGS

HEIGHT: 72 CM

										melamine + 1	
										N fixed top	S sliding top
										For base type : J	
										* left version on the drawing	

										alu, white, black (AL, BI, CZ)	base (desk`s depth)
										148,-	100 x 80

* colour of the cable outlet always matching the base colour

SQart

WORKBENCH - BASE MODULAR UNIT - 4 RECTANGULAR LEGS

HEIGHT: 72 CM

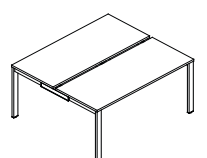
description - page 6		N	... without slot			melamine+ 1		
		L	... 2 left slots			sliding tops		
		R	... 2 right slots					
		T	... slot left and right					
		M	... 2 central slots					
Tops				width	depth			
W	N	S	WB	0 5	N S N Z	120 cm	2 x 60 cm	304,-
W	N	S	WB	0 7	N S N Z	140 cm		347,-
W	N	S	WB	0 9	N S N Z	160 cm	For base type : N	354,-
W	N	S	WB	0 8	N S N Z	140 cm	2 x 80 cm	418,-
W	N	S	WB	1 0	N S N Z	160 cm	For base type : O	426,-
		Z	... top with fixed frame					

Base (Legs)								alu, white, black (AL, BI, CZ)	
W	N	S	N	WN	2	N 0 N N	without height adjustment	N	70,-
W	N	S	N	WO	2	N 0 N N	without height adjustment	O	74,-

WORKBENCH - ADDITIONAL UNIT

With option for central panel fixing

HEIGHT: 72 CM

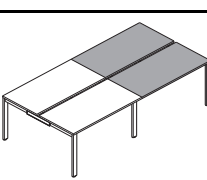
description - page 6		N	... without slot			melamine + 1		
		L	... 2 left slots			sliding tops		
		R	... 2 right slots					
		T	... slot left and right					
		M	... 2 central slots					
Tops				width	depth			
W	N	S	WB	0 5	N S N Z	120 cm	2 x 60 cm	304,-
W	N	S	WB	0 7	N S N Z	140 cm		347,-
W	N	S	WB	0 9	N S N Z	160 cm	For base type : W	354,-
W	N	S	WB	0 8	N S N Z	140 cm	2 x 80 cm	418,-
W	N	S	WB	1 0	N S N Z	160 cm	For base type : X	426,-
		Z	... top with fixed frame					

Base (Legs)								alu, white, black (AL, BI, CZ)	
W	N	S	N	WW	2	N 0 N N	without height adjustment	W	57,-
W	N	S	N	WX	2	N 0 N N	without height adjustment	X	60,-

SQart

WORKBENCH - ADDITIONAL UNIT

Without option for central panel fixing

HEIGHT: 72 CM

description - page 6

N	... without slot
L	... 2 left slots
R	... 2 right slots
T	... slot left and right
M	... 2 central slots

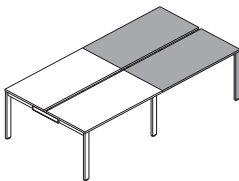
melamine + 1
sliding tops

304,-
347,-
354,-

Tops										width	depth	
W	N	S	WB	0	5	N	S	N	Z	120 cm	2 x 60 cm	304,-
W	N	S	WB	0	7	N	S	N	Z	140 cm		347,-
W	N	S	WB	0	9	N	S	N	Z	160 cm	For base type : Y	354,-
W	N	S	WB	0	8	N	S	N	Z	140 cm	2 x 80 cm	418,-
W	N	S	WB	1	0	N	S	N	Z	160 cm	For base type : Z	426,-

Z ... top with fixed frame

Base (Legs)										alu, white, black (AL, BI, CZ)			
W	N	S	N	W	Y	2	N	0	N	N	without height adjustment	Y	57,-
W	N	S	N	W	Z	2	N	0	N	N	without height adjustment	Z	60,-

SQart

CONFERENCE TABLES

HEIGHT: 72 CM

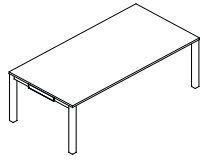
melamine + 1	veneer +4
fixed top	
	

Top										width	depth					
W	N	S	K	2	8	N	N	N	Z	200 cm	100 cm			U	190,-	483,-
W	N	S	K	3	0	N	N	N	Z	240 cm		For base type :		T	235,-	571,-
W	N	S	K	3	2	N	N	N	Z	240 cm	120 cm	For base type :		F	290,-	678,-
W	N	S	K	3	3	N	N	N	Z	140 cm	140 cm	For base type :		V	265,-	558,-
						Z	... top with fixed frame									

- 7 ... wooden legs 60x60 mm
- 2 ... metal leg 60x25 mm

Base (Legs)											wooden legs +4 (LN, LV, CB)	alu, white, black (AL, CZ, BI)		
W	N	S	N	B	U	Z	N	O	N	N	4 legs	U	208,-	106,-
W	N	S	N	B	T	Z	N	O	N	N	6 legs, 2 central legs recessed for 20 cm	T	310,-	187,-
W	N	S	N	B	F	Z	N	O	N	N	6 legs, 2 central legs recessed for 30 cm	F	315,-	198,-
W	N	S	N	B	V	Z	N	O	N	N	4 legs	V	213,-	115,-

SQart

RECTANGULAR DESK EXTENSIONS

2 METAL LEGS
"C" LEG

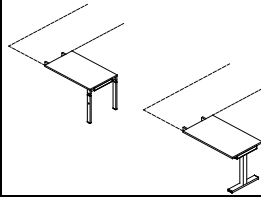
Top											width		depth		melamine + 1
W	N	S	A	0	1	N	N	N	Z		80 cm		60 cm		fixed top
W	N	S	A	0	3	N	N	N	Z		100 cm				
															113,-
															129,-

Z ... top with fixed frame

Base (Legs)

2 METAL LEGS

											alu, white, black (AL, CZ, BI)		
W	N	S	N	A	A	2	N	0	N	N	without height adjustment		54,-
W	N	S	N	A	A	2	H	0	N	N	with manual height adj. (68-82 cm)		79,-

"C" LEG

											alu, white, black (AL, CZ, BI)		
W	N	S	N	A	A	3	N	0	N	N	without height adjustment		90,-
W	N	S	N	A	A	3	H	0	N	N	with manual height adj. (68-82 cm)		100,-

SQart

MODESTY PANELS FOR DESKS

When applying the modesty panel the table panel cannot be fitted.

							length		melamine + 1	
W	N	S	P	D	T	1 2	N N	120 cm		59,-
W	N	S	P	D	T	1 4	N N	140 cm		61,-
W	N	S	P	D	T	1 6	N N	160 cm		63,-
W	N	S	P	D	T	1 8	N N	180 cm		65,-
W	N	S	P	D	T	2 0	N N	200 cm		67,-

TABLE PANELS FOR DESKS

When applying the table panel the modesty panel cannot be fitted.

							length		melamine + 1	
W	N	S	P	G	T	1 2	L N	120 cm		76,-
W	N	S	P	G	T	1 4	L N	140 cm		79,-
W	N	S	P	G	T	1 6	L N	160 cm		91,-
W	N	S	P	G	T	1 8	L N	180 cm		104,-
W	N	S	P	G	T	2 0	L N	200 cm		108,-

ONE-PIECE TABLE AND MODESTY PANELS

							length		melamine + 1	
W	N	S	P	K	T	1 2	L N	120 cm		80,-
W	N	S	P	K	T	1 4	L N	140 cm		89,-
W	N	S	P	K	T	1 6	L N	160 cm		102,-
W	N	S	P	K	T	1 8	L N	180 cm		106,-
W	N	S	P	K	T	2 0	L N	200 cm		110,-

SQart

TABLE PANELS FOR ANGLED DESKS (120 DEGREES)

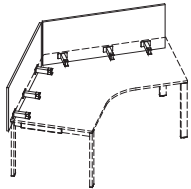
										length		melamine + 1	
W	N	S	P	G	B	1	2	L	N	120 cm		71,-	
W	N	S	P	G	B	1	4	L	N	140 cm		76,-	

* one piece of panels

ABOVE DESK CENTRAL SCREENS FOR WORKBENCH

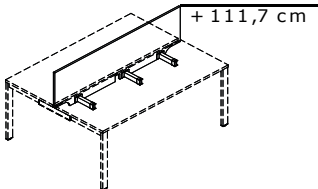
										length		melamine + 1	
W	N	S	P	G	W	1	2	L	N	120 cm		89,-	
W	N	S	P	G	W	1	4	L	N	140 cm		93,-	
W	N	S	P	G	W	1	6	L	N	160 cm		104,-	

ABOVE DESK DIVIDING SCREENS FOR WORKBENCH

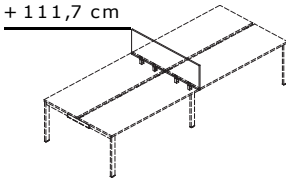
										length		melamine + 1	
W	N	S	P	S	W	1	2	L	N	120 cm		63,-	
W	N	S	P	S	W	1	6	L	N	160 cm		77,-	

SIDE TABLE PANELS

Side table panels for fixed tops cannot be applied as modesty panels.

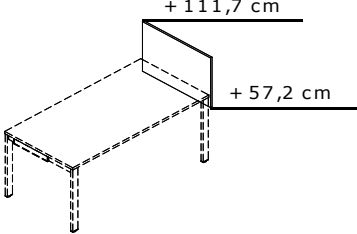
										length		melamine + 1	
W	N	S	P	G	B	0	6	L	N	60 cm		38,-	
W	N	S	P	G	B	0	7	L	N	70 cm		41,-	
W	N	S	P	G	B	0	8	L	N	80 cm		42,-	
W	N	S	P	G	B	0	9	L	N	90 cm		44,-	
W	N	S	P	G	B	1	0	L	N	100 cm		47,-	
W	N	S	P	G	B	1	2	L	N	120 cm		71,-	
W	N	S	P	G	B	1	4	L	N	140 cm		76,-	
W	N	S	P	G	B	1	6	L	N	160 cm		88,-	

SQart

MOBILE PEDESTALS

HEIGHT: 57 CM

WIDTH: 43 CM

M
S

... 80 % extendable metal drawers

... 80 % extendable metal drawers, 100 % extendable drawer with file frame

melamine + 1		+1 / +4 *	
M	S	M	S
80 %	80 %/ 100 %	80 %	80 %/ 100 %

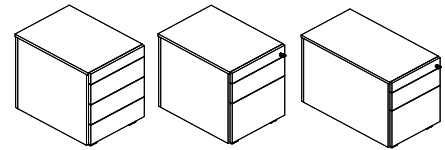

depth pencil drawer + 3 drawers

W	N	S	C	M	3	1	6	M	N	Z	60 cm	251,-		534,-	
												pencil drawer + 1 drawer + 1 drawer with file frame			
W	N	S	C	M	2	1	6	M	N	Z	60 cm	243,-	329,-	500,-	586,-
W	N	S	C	M	2	1	8	M	N	Z	80 cm	268,-	331,-		

* top and front - veneer, carcass - melamine

SQart

FREE STANDING PEDESTALS ON FEET

HEIGHT: 72 CM

WIDTH: 43 CM

M ... 80 % extendable metal drawers
S ... 80 % extendable metal drawers, 100 % extendable drawer with file frame

										melamine + 1		+ 1 / + 4 *			
										M	S	M	S		
										80 %	80 %/ 100 %	80 %	80 %/ 100 %		
										depth		pencil drawer + 4 drawers			
W	N	S	C	F	4	1	6	M	N	Z	60 cm	315,-			
										pencil drawer + 2 drawers + 1 drawer with file frame					
W	N	S	C	F	3	1	6	M	N	Z	60 cm	305,-	391,-		
W	N	S	C	F	3	1	8	M	N	Z	80 cm	337,-	423,-	660,-	746,-
										pencil drawer + 2 drawers with file frame					
W	N	S	C	F	2	1	6	M	N	Z	60 cm	279,-	382,-		
W	N	S	C	F	2	1	8	M	N	Z	80 cm	312,-	414,-		

* top and front - veneer, carcass - melamine

FREE STANDING PEDESTALS WITH METAL BASE

HEIGHT: 72 CM

WIDTH: 43 CM

M ... 80 % extendable metal drawers
S ... 80 % extendable metal drawers, 100 % extendable drawer with file frame

										melamine + 1		+ 1 / + 4 *			
										M	S	M	S		
										80 %	80 %/ 100 %	80 %	80 %/ 100 %		
										depth		pencil drawer + 4 drawers			
W	N	S	C	C	4	1	6	M	N	Z	60 cm	341,-			
										pencil drawer + 2 drawers + 1 drawer with file frame					
W	N	S	C	C	3	1	6	M	N	Z	60 cm	331,-	417,-		
W	N	S	C	C	3	1	8	M	N	Z	80 cm	366,-	452,-	690,-	776,-
										pencil drawer + 2 drawers with file frame					
W	N	S	C	C	2	1	6	M	N	Z	60 cm	305,-	408,-		
W	N	S	C	C	2	1	8	M	N	Z	80 cm	342,-	443,-		

* top and front - veneer, carcass - melamine

SQart

MOBILE PEDESTALS WITH FIFTH CASTOR FIXED TO THE BOTTOM DRAWER HEIGHT: 57 CM WIDTH: 43 CM

K
D

... 80 % extendable metal drawers with an additional castor fixed to the bottom drawer

... 80 % extendable metal drawers, 100 % extendable drawer with file frame with an additional castor

depth

pencil drawer + 1 drawer + 1 drawer with file frame

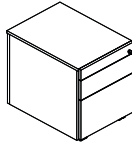
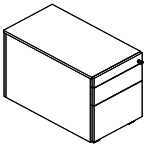
melamine + 1		+ 1 / + 4 *	
K 80 %	D 80%/100%	K 80 %	D 80%/100%
			
253,-	270,-	510,-	526,-
278,-	295,-		

W N S C M	2 1 6	K N Z	60 cm	253,-	270,-	510,-	526,-
W N S C M	2 1 8	K N Z	80 cm	278,-	295,-		

* top and front - veneer, carcass - melamine

FREE STANDING PEDESTALS ON FEET WITH FIFTH CASTOR FIXED TO THE BOTTOM DRAWER HEIGHT: 72 CM WIDTH: 43 CM

K
D

... 80 % extendable metal drawers with an additional castor fixed to the bottom drawer

... 80 % extendable metal drawers, 100 % extendable drawer with file frame with an additional castor

depth

pencil drawer + 2 drawers + 1 drawer with file frame

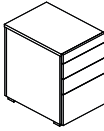
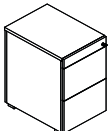
melamine + 1		+ 1 / + 4 *	
K 80 %	D 80%/100%	K 80 %	D 80%/100%
			
317,-	333,-		
349,-	365,-	673,-	688,-

W N S C F	3 1 6	K N Z	60 cm	317,-	333,-		
W N S C F	3 1 8	K N Z	80 cm	349,-	365,-	673,-	688,-

pencil drawer + 2 drawers with file frame

W N S C F	2 1 6	K N Z	60 cm	292,-	324,-		
W N S C F	2 1 8	K N Z	80 cm	324,-	356,-		

* top and front - veneer, carcass - melamine

SQart

SLIDING DOOR CABINETS

WIDTH 120 CM

DEPTH 44,5 CM

											+ 1 / + 4						
											melamine + 1		melamine/veener *				
											C	F	C	F			
											Cabinet with metal base	Cabinet on feet	Cabinet with metal base	Cabinet on feet			
W	N	S	S	C	S	1	2	1	N	P	A	N	1,5 OH (72 cm)	342,-	283,-		
W	N	S	S	C	S	1	2	2	N	P	A	N	2 OH (76,5 cm)	345,-	286,-		
W	N	S	S	C	S	1	2	3	N	P	A	N	3 OH (111,7 cm)	400,-	341,-	731,-	677,-
W	N	S	S	C	S	1	2	4	N	P	A	N	4 OH (146,9 cm)	456,-	399,-	826,-	774,-

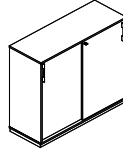

Z ... veneered (open) cabinets assembled in standard

C ... cabinet with metal base (as shown in illustration)

F ... cabinet on feet

* top and front (if applicable) - veneer, carcass - melamine

UPPER - SLIDING DOOR CABINETS

WIDTH 120 CM

DEPTH 44,5 CM

											melamine + 1			
W	N	S	S	A	S	1	2	0	N	P	A	N	1 OH (37 cm)	227,-
W	N	S	S	A	S	1	2	2	N	P	A	N	2 OH (72,2 cm)	283,-
W	N	S	S	A	S	1	2	3	N	P	A	N	3 OH (107,4 cm)	338,-
W	N	S	S	A	S	1	2	4	N	P	A	N	4 OH (142,6 cm)	395,-

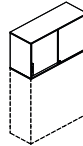

SLIDING DOOR CABINETS

WIDTH 160 CM

DEPTH 44,5 CM

											+ 1 / + 4						
											melamine + 1		melamine/veener *				
											C	F	C	F			
											Cabinet with metal base	Cabinet on feet	Cabinet with metal base	Cabinet on feet			
W	N	S	S	C	S	1	6	1	N	P	A	N	1,5 OH (72 cm)	408,-	343,-		
W	N	S	S	C	S	1	6	2	N	P	A	N	2 OH (76,5 cm)	411,-	346,-		
W	N	S	S	C	S	1	6	3	N	P	A	N	3 OH (111,7 cm)	479,-	414,-	875,-	816,-
W	N	S	S	C	S	1	6	4	N	P	A	N	4 OH (146,9 cm)	552,-	490,-	994,-	937,-

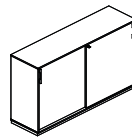

Z ... veneered (open) cabinets assembled in standard

C ... cabinet with metal base (as shown in illustration)

F ... cabinet on feet

* top and front (if applicable) - veneer, carcass - melamine

UPPER - SLIDING DOOR CABINETS

WIDTH 160 CM

DEPTH 44,5 CM

											melamine + 1			
W	N	S	S	A	S	1	6	0	N	P	A	N	1 OH (37 cm)	273,-
W	N	S	S	A	S	1	6	2	N	P	A	N	2 OH (72,2 cm)	343,-
W	N	S	S	A	S	1	6	3	N	P	A	N	3 OH (107,4 cm)	396,-
W	N	S	S	A	S	1	6	4	N	P	A	N	4 OH (142,6 cm)	461,-

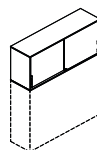

SQart

TAMBOUR CABINETS

WIDTH 80 CM

DEPTH 44,5 CM

W	N	S	S	C	T	0	8	1	N	P	A	Z	1,5 OH (72 cm)
W	N	S	S	C	T	0	8	2	N	P	A	Z	2 OH (76,5 cm)
W	N	S	S	C	T	0	8	3	N	P	A	Z	3 OH (111,7 cm)
W	N	S	S	C	T	0	8	4	N	P	A	Z	4 OH (146,9 cm)
W	N	S	S	C	T	0	8	5	N	P	A	Z	5 OH (183,9 cm)

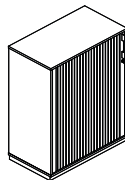

		+ 1 / + 4	
melamine + 1		melamine/veneer *	
C	F	C	F
Cabinet with metal base	Cabinet on feet	Cabinet with metal base	Cabinet on feet
292,-	243,-		
294,-	245,-		
353,-	304,-	454,-	404,-
450,-	401,-	551,-	501,-
502,-	453,-	603,-	553,-

C ... cabinet with metal base (as shown in illustration)
F ... cabinet on feet

* top and front (if applicable) - veneer, carcass - melamine

UPPER - TAMBOUR CABINETS

WIDTH 80 CM

DEPTH 44,5 CM

W	N	S	S	A	T	0	8	0	N	P	A	Z	1 OH (37 cm)
W	N	S	S	A	T	0	8	2	N	P	A	Z	2 OH (72,2 cm)
W	N	S	S	A	T	0	8	3	N	P	A	Z	3 OH (107,4 cm)
W	N	S	S	A	T	0	8	4	N	P	A	Z	4 OH (142,6 cm)

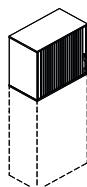

melamine + 1
209,-
243,-
303,-
400,-

TAMBOUR CABINETS

WIDTH 120 CM

DEPTH 44,5 CM

W	N	S	S	C	T	1	2	1	N	P	A	Z	1,5 OH (72 cm)
W	N	S	S	C	T	1	2	2	N	P	A	Z	2 OH (76,5 cm)
W	N	S	S	C	T	1	2	3	N	P	A	Z	3 OH (111,7 cm)
W	N	S	S	C	T	1	2	4	N	P	A	Z	4 OH (146,9 cm)

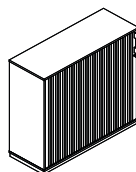

		+ 1 / + 4	
melamine + 1		melamine/veneer *	
C	F	C	F
Cabinet with metal base	Cabinet on feet	Cabinet with metal base	Cabinet on feet
395,-	326,-		
397,-	328,-		
485,-	416,-	608,-	540,-
631,-	562,-	754,-	685,-

C ... cabinet with metal base (as shown in illustration)
F ... cabinet on feet

* top and front (if applicable) - veneer, carcass - melamine

UPPER - TAMBOUR CABINETS

WIDTH 120 CM

DEPTH 44,5 CM

W	N	S	S	A	T	1	2	0	N	P	A	Z	1 OH (37 cm)
W	N	S	S	A	T	1	2	2	N	P	A	Z	2 OH (72,2 cm)
W	N	S	S	A	T	1	2	3	N	P	A	Z	3 OH (107,4 cm)
W	N	S	S	A	T	1	2	4	N	P	A	Z	4 OH (142,6 cm)

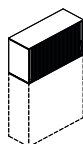

melamine + 1
260,-
324,-
413,-
553,-

SQart

TAMBOUR CABINETS

WIDTH 160 CM

DEPTH 44,5 CM

W	N	S	S	C	T	1	6	1	N	P	A	Z	1,5 OH (72 cm)
W	N	S	S	C	T	1	6	2	N	P	A	Z	2 OH (76,5 cm)
W	N	S	S	C	T	1	6	3	N	P	A	Z	3 OH (111,7 cm)
W	N	S	S	C	T	1	6	4	N	P	A	Z	4 OH (146,9 cm)

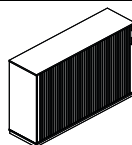

		+ 1 / + 4	
melamine + 1		melamine/veneer *	
C	F	C	F
Cabinet with metal base	Cabinet on feet	Cabinet with metal base	Cabinet on feet
448,-	373,-		
451,-	376,-		
551,-	476,-	702,-	628,-
710,-	635,-	862,-	787,-

* top and front (if applicable) - veneer, carcass - melamine

C ... cabinet with metal base (as shown in illustration)
F ... cabinet on feet

UPPER - TAMBOUR CABINETS

WIDTH 160 CM

DEPTH 44,5 CM

W	N	S	S	A	T	1	6	0	N	P	A	Z	1 OH (37 cm)
W	N	S	S	A	T	1	6	2	N	P	A	Z	2 OH (72,2 cm)
W	N	S	S	A	T	1	6	3	N	P	A	Z	3 OH (107,4 cm)
W	N	S	S	A	T	1	6	4	N	P	A	Z	4 OH (142,6 cm)

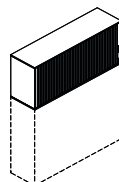

melamine + 1	
294,-	
372,-	
471,-	
609,-	

HINGED DOORS CABINETS

WIDTH 60 CM

DEPTH 44,5 CM

													P	... melamine chipboard shelf
													M	... metal shelf surcharge 4,- EUR
W	N	S	S	C	W	0	6	1	L	P	A	N	1,5 OH (72 cm)	
W	N	S	S	C	W	0	6	2	L	P	A	N	2 OH (76,5 cm)	
W	N	S	S	C	W	0	6	3	L	P	A	N	3 OH (111,7 cm)	
W	N	S	S	C	W	0	6	4	L	P	A	N	4 OH (146,9 cm)	
W	N	S	S	C	W	0	6	5	L	P	A	N	5 OH (183,9 cm)	
W	N	S	S	C	W	0	6	6	L	P	A	N	6 OH (219,1 cm)	

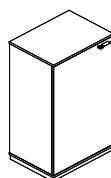

melamine + 1	
C	F
Cabinet with metal base	Cabinet on feet
172,-	134,-
174,-	136,-
202,-	164,-
250,-	213,-
273,-	237,-
298,-	263,-

L ... left version
R ... right version
C ... cabinet with metal base (as shown in illustration)
F ... cabinet on feet

UPPER - HINGED DOOR CABINETS

WIDTH 60 CM

DEPTH 44,5 CM

													P	... melamine chipboard shelf
													M	... metal shelf surcharge 4,- EUR
W	N	S	S	A	W	0	6	0	L	P	A	N	1 OH (37 cm)	
W	N	S	S	A	W	0	6	2	L	P	A	N	2 OH (72,2 cm)	
W	N	S	S	A	W	0	6	3	L	P	A	N	3 OH (107,4 cm)	
W	N	S	S	A	W	0	6	4	L	P	A	N	4 OH (142,6 cm)	

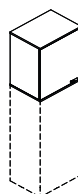

melamine + 1	
107,-	
135,-	
163,-	
202,-	

L ... left version
R ... right version

SQart

HINGED DOORS CABINETS

WIDTH 80 CM
DEPTH 44,5 CM

											+ 1 / + 4						
											melamine + 1		melamine/veneer *				
											C	F	C	F			
											Cabinet with metal base	Cabinet on feet	Cabinet with metal base	Cabinet on feet			
W	N	S	S	C	W	0	8	1	N	P	A	N	1,5 OH (72 cm)	210,-	169,-		
W	N	S	S	C	W	0	8	2	N	P	A	N	2 OH (76,5 cm)	212,-	172,-		
W	N	S	S	C	W	0	8	3	N	P	A	N	3 OH (111,7 cm)	249,-	209,-	547,-	510,-
W	N	S	S	C	W	0	8	4	N	P	A	N	4 OH (146,9 cm)	325,-	286,-	647,-	612,-
W	N	S	S	C	W	0	8	5	N	P	A	N	5 OH (183,9 cm)	356,-	318,-	692,-	658,-
W	N	S	S	C	W	0	8	6	N	P	A	N	6 OH (219,1 cm)	386,-	349,-		

P ... melamine chipboard shelf
M ... metal shelf **surcharge 4,- EUR**

C ... cabinet with metal base (as shown in illustration)
F ... cabinet on feet

Z ... veneered (open) cabinets assembled in standard

* top and front (if applicable) - veneer, carcass - melamine

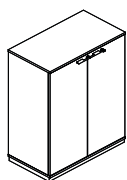

UPPER - HINGED DOOR CABINETS

WIDTH 80 CM
DEPTH 44,5 CM

											melamine + 1			
W	N	S	S	A	W	0	8	0	N	P	A	N	1 OH (37 cm)	133,-
W	N	S	S	A	W	0	8	2	N	P	A	N	2 OH (72,2 cm)	170,-
W	N	S	S	A	W	0	8	3	N	P	A	N	3 OH (107,4 cm)	208,-
W	N	S	S	A	W	0	8	4	N	P	A	N	4 OH (142,6 cm)	261,-

P ... melamine chipboard shelf
M ... metal shelf **surcharge 4,- EUR**

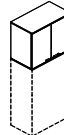

HINGED DOORS CABINETS

WIDTH 100 CM
DEPTH 44,5 CM

											+ 1 / + 4						
											melamine + 1		melamine/veneer *				
											C	F	C	F			
											Cabinet with metal base	Cabinet on feet	Cabinet with metal base	Cabinet on feet			
W	N	S	S	C	W	1	0	1	N	S	A	N	1,5 OH (72 cm)	246,-	202,-		
W	N	S	S	C	W	1	0	2	N	S	A	N	2 OH (76,5 cm)	248,-	205,-		
W	N	S	S	C	W	1	0	3	N	S	A	N	3 OH (111,7 cm)	310,-	266,-	650,-	611,-
W	N	S	S	C	W	1	0	4	N	S	A	N	4 OH (146,9 cm)	404,-	362,-	775,-	736,-
W	N	S	S	C	W	1	0	5	N	S	A	N	5 OH (183,9 cm)	455,-	414,-	842,-	805,-
W	N	S	S	C	W	1	0	6	N	S	A	N	6 OH (219,1 cm)	511,-	471,-		

S ... reinforced shelf
M ... metal shelf

C ... cabinet with metal base (as shown in illustration)
F ... cabinet on feet

Z ... veneered (open) cabinets assembled in standard

* top and front (if applicable) - veneer, carcass - melamine

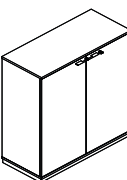

UPPER - HINGED DOOR CABINETS

WIDTH 100 CM
DEPTH 44,5 CM

											melamine + 1			
W	N	S	S	A	W	1	0	0	N	S	A	N	1 OH (37 cm)	142,-
W	N	S	S	A	W	1	0	2	N	S	A	N	2 OH (72,2 cm)	202,-
W	N	S	S	A	W	1	0	3	N	S	A	N	3 OH (107,4 cm)	264,-
W	N	S	S	A	W	1	0	4	N	S	A	N	4 OH (142,6 cm)	349,-

S ... reinforced shelf
M ... metal shelf



SQart

OPEN CABINETS

WIDTH 60 CM

DEPTH 44,5 CM

P ... melamine chipboard shelf
M ... metal shelf **surcharge 4,- EUR**

melamine + 1	
C Open cabinet with metal base	F Open cabinet on feet
150,-	107,-
151,-	109,-
179,-	136,-
210,-	169,-
241,-	200,-
265,-	224,-

W	N	S	S	C	N	0	6	1	N	P	N	N	OH (cm)
W	N	S	S	C	N	0	6	1	N	P	N	N	1,5 OH (72 cm)
W	N	S	S	C	N	0	6	2	N	P	N	N	2 OH (76,5 cm)
W	N	S	S	C	N	0	6	3	N	P	N	N	3 OH (111,7 cm)
W	N	S	S	C	N	0	6	4	N	P	N	N	4 OH (146,9 cm)
W	N	S	S	C	N	0	6	5	N	P	N	N	5 OH (183,9 cm)
W	N	S	S	C	N	0	6	6	N	P	N	N	6 OH (219,1 cm)

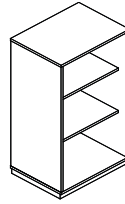

C ... cabinet with metal base (as shown in illustration)
F ... cabinet on feet

UPPER - OPEN CABINETS

WIDTH 60 CM

DEPTH 44,5 CM

P ... melamine chipboard shelf
M ... metal shelf **surcharge 4,- EUR**

melamine + 1	
84,-	
110,-	
138,-	
171,-	

W	N	S	S	A	N	0	6	0	N	P	N	N	OH (cm)
W	N	S	S	A	N	0	6	0	N	P	N	N	1 OH (37 cm)
W	N	S	S	A	N	0	6	2	N	P	N	N	2 OH (72,2 cm)
W	N	S	S	A	N	0	6	3	N	P	N	N	3 OH (107,4 cm)
W	N	S	S	A	N	0	6	4	N	P	N	N	4 OH (142,6 cm)

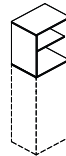

OPEN CABINETS

WIDTH 80 CM

DEPTH 44,5 CM

P ... melamine chipboard shelf
M ... metal shelf **surcharge 4,- EUR**

melamine + 1		+ 1 / + 4	
C Open cabinet with metal base	F Open cabinet on feet	C Open cabinet with metal base	F Open cabinet on feet
165,-	121,-		
166,-	122,-		
199,-	154,-	306,-	265,-
238,-	195,-	340,-	301,-
271,-	228,-	370,-	331,-
296,-	253,-		

W	N	S	S	C	N	0	8	1	N	P	N	N	OH (cm)
W	N	S	S	C	N	0	8	1	N	P	N	N	1,5 OH (72 cm)
W	N	S	S	C	N	0	8	2	N	P	N	N	2 OH (76,5 cm)
W	N	S	S	C	N	0	8	3	N	P	N	N	3 OH (111,7 cm)
W	N	S	S	C	N	0	8	4	N	P	N	N	4 OH (146,9 cm)
W	N	S	S	C	N	0	8	5	N	P	N	N	5 OH (183,9 cm)
W	N	S	S	C	N	0	8	6	N	P	N	N	6 OH (219,1 cm)

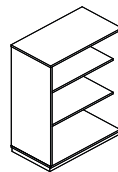

Z ... veneered (open) cabinets assembled in standard

C ... cabinet with metal base (as shown in illustration)
F ... cabinet on feet

* top and front (if applicable) - veneer, carcass - melamine

UPPER - OPEN CABINETS

WIDTH 80 CM

DEPTH 44,5 CM

P ... melamine chipboard shelf
M ... metal shelf **surcharge 4,- EUR**

melamine + 1	
92,-	
124,-	
156,-	
197,-	

W	N	S	S	A	N	0	8	0	N	P	N	N	OH (cm)
W	N	S	S	A	N	0	8	0	N	P	N	N	1 OH (37 cm)
W	N	S	S	A	N	0	8	2	N	P	N	N	2 OH (72,2 cm)
W	N	S	S	A	N	0	8	3	N	P	N	N	3 OH (107,4 cm)
W	N	S	S	A	N	0	8	4	N	P	N	N	4 OH (142,6 cm)

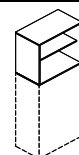

SQart

OPEN CABINETS

WIDTH 100 CM

DEPTH 44,5 CM

													+ 1 / + 4				
													melamine + 1		melamine/veener *		
													C	F	C	F	
													Open cabinet with metal base	Open cabinet on feet	Open cabinet with metal base	Open cabinet on feet	
W	N	S	S	C	N	1	0	1	N	S	N	N	1,5 OH (72 cm)	202,-	153,-		
W	N	S	S	C	N	1	0	2	N	S	N	N	2 OH (76,5 cm)	203,-	155,-		
W	N	S	S	C	N	1	0	3	N	S	N	N	3 OH (111,7 cm)	260,-	212,-	384,-	340,-
W	N	S	S	C	N	1	0	4	N	S	N	N	4 OH (146,9 cm)	323,-	277,-	440,-	397,-
W	N	S	S	C	N	1	0	5	N	S	N	N	5 OH (183,9 cm)	381,-	335,-	496,-	453,-
W	N	S	S	C	N	1	0	6	N	S	N	N	6 OH (219,1 cm)	433,-	386,-		

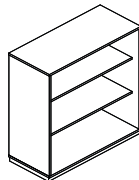

Z ... veneered (open) cabinets assembled in standard

S ... reinforced shelf
M ... metal shelf

C ... cabinet with metal base (as shown in illustration)
F ... cabinet on feet

* top and front (if applicable) - veneer, carcass - melamine

UPPER - OPEN CABINETS

WIDTH 100 CM

DEPTH 44,5 CM

													melamine + 1	
W	N	S	S	A	N	1	0	0	N	S	N	N	1 OH (37 cm)	100,-
W	N	S	S	A	N	1	0	2	N	S	N	N	2 OH (72,2 cm)	156,-
W	N	S	S	A	N	1	0	3	N	S	N	N	3 OH (107,4 cm)	214,-
W	N	S	S	A	N	1	0	4	N	S	N	N	4 OH (142,6 cm)	246,-

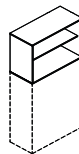

S ... reinforced shelf
M ... metal shelf

GLASS DOORS CABINETS

WIDTH 80 CM

DEPTH 44,5 CM

													+ 1 / + 4				
													melamine + 1		melamine/veener *		
													C	F	C	F	
													Cabinet with metal base	Cabinet on feet	Cabinet with metal base	Cabinet on feet	
W	N	S	S	C	G	0	8	2	N	P	A	N	2 OH (76,5 cm)	323,-	279,-		
W	N	S	S	C	G	0	8	3	N	P	A	N	3 OH (111,7 cm)	387,-	344,-	465,-	425,-
W	N	S	S	C	G	0	8	4	N	P	A	N	4 OH (146,9 cm)	494,-	453,-	579,-	540,-

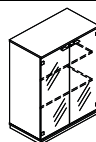

Z ... veneered (open) cabinets assembled in standard

C ... cabinet with metal base (as shown in illustration)
F ... cabinet on feet

* top and front (if applicable) - veneer, carcass - melamine

UPPER - GLASS HINGED DOOR CABINETS

WIDTH 80 CM

DEPTH 44,5 CM

													melamine + 1	
W	N	S	S	A	G	0	8	2	N	P	A	N	2 OH (72,2 cm)	281,-
W	N	S	S	A	G	0	8	3	N	P	A	N	3 OH (107,4 cm)	346,-
W	N	S	S	A	G	0	8	4	N	P	A	N	4 OH (142,6 cm)	467,-

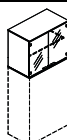

SQart

CABINETS WITH DRAWERS

WIDTH 80 CM

DEPTH 44,5 CM

											+ 1 / + 4								
											melamine + 1			melamine/veneer *					
											D	E	F	D	E	F			
											file frame	file frame + drawer	metal drawers	file frame	file frame + drawer	metal drawers			
W	N	S	S	C	D	0	8	2	N	N	A	Z	2 OH (76,5 cm) with metal base	523,-	647,-	776,-			
W	N	S	S	F	D	0	8	2	N	N	A	Z	2 OH (76,5 cm) on feet	483,-	607,-	734,-			
W	N	S	S	C	D	0	8	3	N	N	A	Z	3 OH (111,7 cm) with metal base	694,-	822,-	1 082,-	1 107,-	1 288,-	1 654,-
W	N	S	S	F	D	0	8	3	N	N	A	Z	3 OH (111,7 cm) on feet	651,-	779,-	1 039,-	1 063,-	1 245,-	1 612,-

- D ... 2 filing frame drawers
- E ... 2 metal drawers + bottom filing frame drawer
- F ... metal drawers

* top and front (if applicable) - veneer, carcass - melamine

WARDROBE CABINETS

WIDTH 60 CM

DEPTH 44,5 CM

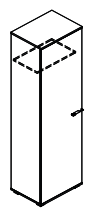
											melamine + 1				
											C	F			
											Cabinet with metal base	Cabinet on feet			
W	N	S	S	C	U	0	6	5	L	P	A	N	5 OH (183,9 cm)	257,-	223,-
W	N	S	S	C	U	0	6	6	L	P	A	N	6 OH (219,1 cm)	273,-	239,-

- L ... left version
- R ... right version

- C ... cabinet with metal base (as shown in illustration)
- F ... cabinet on feet

WARDROBE CABINETS

WIDTH 80 CM

DEPTH 44,5 CM

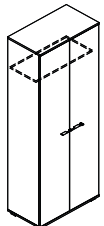
											melamine + 1		melamine/veneer *				
											C	F	C	F			
											Cabinet with metal base	Cabinet on feet	Cabinet with metal base	Cabinet on feet			
W	N	S	S	C	U	0	8	5	N	P	A	N	5 OH (183,9 cm)	331,-	396,-	667,-	633,-
W	N	S	S	C	U	0	8	6	N	P	A	N	6 OH (219,1 cm)	350,-	314,-		

Z ... veneered (open) cabinets assembled in standard

- C ... cabinet with metal base (as shown in illustration)
- F ... cabinet on feet

* top and front (if applicable) - veneer, carcass - melamine

WARDROBE CABINETS

WIDTH 80 CM

DEPTH 60 CM

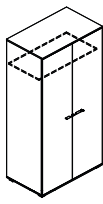
											melamine + 1				
											M	K			
											Cabinet with metal base	Cabinet on feet			
W	N	S	S	M	U	0	8	5	N	P	A	N	5 OH (183,9 cm)	349,-	311,-
W	N	S	S	M	U	0	8	6	N	P	A	N	6 OH (219,1 cm)	370,-	333,-

- M ... cabinet with metal base
- K ... cabinet on feet